

RF wireless LED remote controller

Model:SR-2819DIM with SR-1009Fxx



- 6 zones/areas
- Press-button Dimmer
- Receivers work with WIFI-RF converter to be controlled by smart phone



Parameter

Remote

Part No.	Operation Voltage	Operation Frequency	DIMENSIONS ø/h (mm)	Remarks
SR-2819DIM	4.5VDC	434MHz/868MHz	48x140x17	load 3pcs 7 AAA (1.5V) batteries

Receiver

Part No.	Input Voltage	Output Current	Output Power	Remarks
SR-1009FA	12-36VDC	4x5A	4x(60-180)W	Constant voltage
SR-1009EA	12-36VDC	4x8A	4x(96-288)W	Constant voltage
SR-1009FA3	12-36VDC	4x350mA	4x(4.2-12.6)W	Constant current
SR-1009FA7	12-36VDC	4x700mA	4x(8.4-25.2)W	Constant current

Product Size

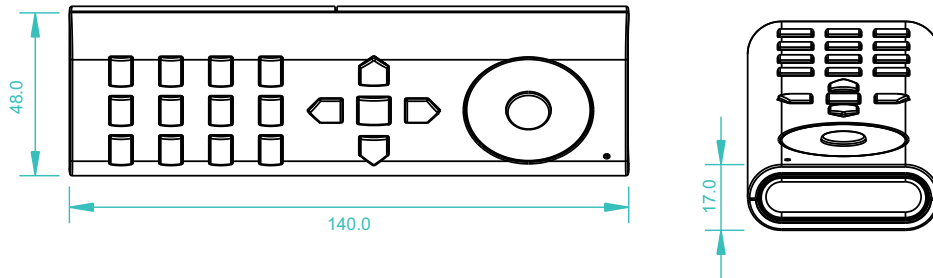

Brief introduction of buttons

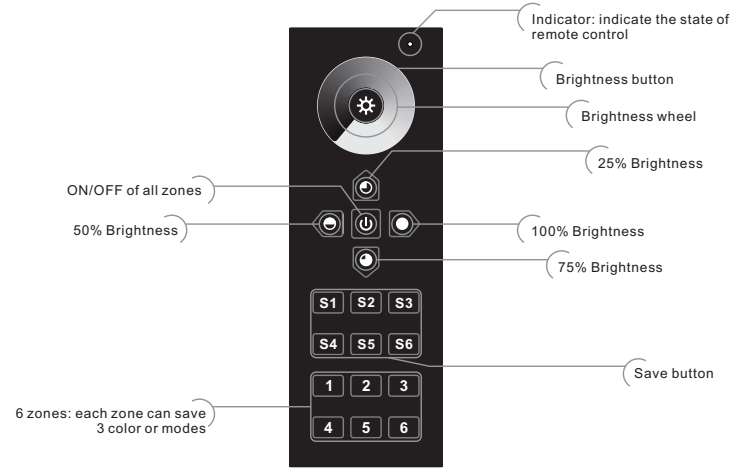

Wiring diagram

1)Receiver Connection Diagram for Single Unit

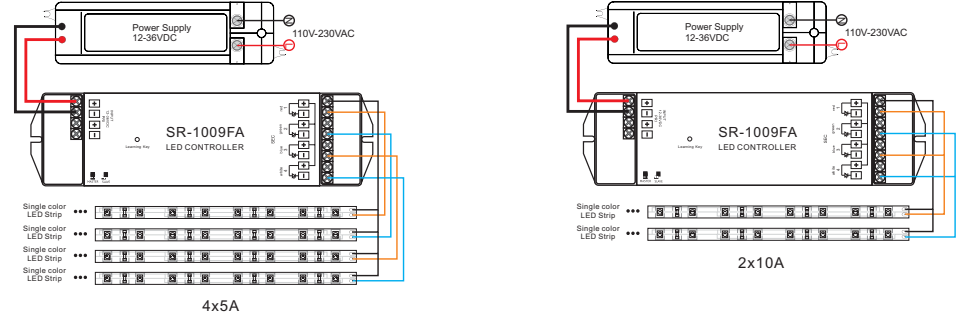

2)Receiver Connection Diagram for Multiple Units

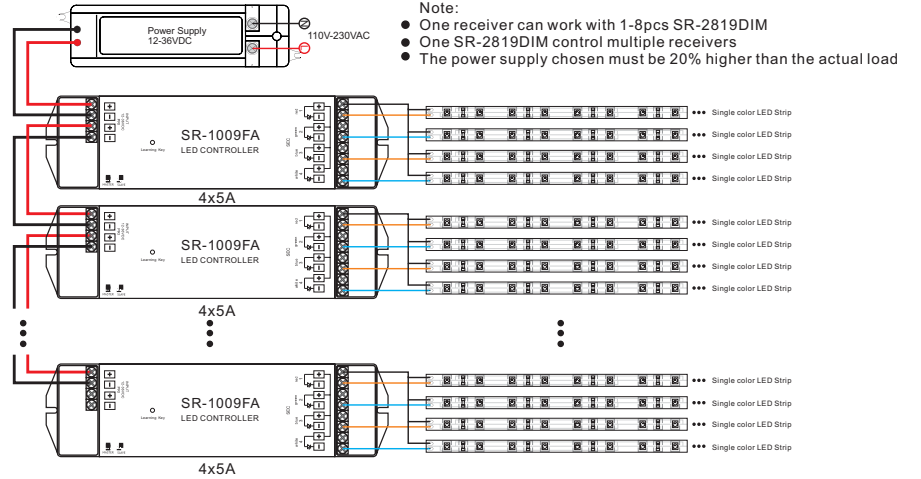

Operation

Learning (matching)

- Do wiring according to connection diagram
- Wake up the remote control by touching ON/OFF button.
- Press learning button on receiver.
- Touch any zone button on remote control.
- Then touch brightness wheel.
- Connected LED light will blink to confirm zone designation.
- Press at learning button on receiver over 5 seconds until LED light flash, then delete the learned ID.

Note 1: To choose a master from slaves by jumper for each zone.

Short circuit for master.

Open circuit for slave.

Each zone only can set one master controller. After a period of time, the master will do synchronization operation to keep the same color or mode of all slaves in one zone.

Note 2: Each remote control 6 zones (areas) receivers, each area can be learned as many receivers as we can.

Each receiver maximally can be controlled by 8 different remote controllers.





Dim wheel

Choose zone number , for example,  and , then touch , choose the brightness you want, zone 1 and 3 will indicate corresponding brightness as we touched.

Brightness Up & Down Button

Long Press button  to dim down/up brightness, the dimming direction will change every time after pressing switch. For example, the first long press is brightness up, it will be dimmed down when long press again.



Brightness level button

Select zone from . Press , the corresponding zones will be 25% brightness. Press , the corresponding zones will be 50% brightness. Press , the corresponding zones will be 75% brightness. Press , the corresponding zones will be 100% brightness.

Save and recall button

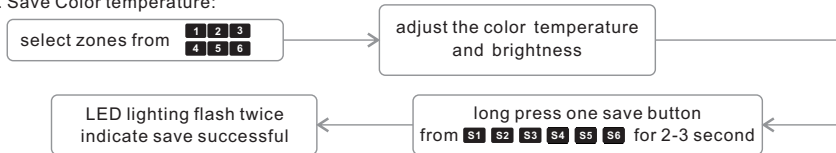
- Save Color temperature:



- Recall: select zone button which we want recall from , then short press save button .

Safety & Warnings

- The product shall be installed and serviced by a qualified person.
- IP20. Please avoid the sun and rain. When installed outdoors, please ensure it is mounted in a water proof enclosure.
- Always be sure to mount this unit in an area with proper ventilation to avoid overheating.
- Please check if the output voltage of any LED power supplies used comply with the working voltage of the product.
- Never connect any cables while power is on and always assure correct connections to avoid short circuits before switching on.
- Please ensure that the cable is secured tightly in the connector
- For update information please consult your supplier.

Warranty Agreement

1) We provide lifelong technical assistance with this product:

- 5-year warranty. We print date on every products, for example :1125 means year 2011, week 25. The warranty is for free repair or replacement and covers manufacturing faults only.

- For faults beyond the 5-year warranty we reserve the right to charge for time and parts.

2) Limited Warranty

- Any defects caused by wrong operation.

- Any damages caused by unauthorized removal, maintenance, modifying, incorrect connection and replacement of chips.

- Any damages due to transportation, vibration etc. after purchase.

- Any damages caused by earthquake, fire, lightning, pollution and abnormal voltage.

- Any damages caused by negligence, inappropriate storing at high temperatures and humidity or near harmful chemicals.

- Product has been updated

3) Repair or replacement as provided under this warranty is the exclusive remedy to the customer.